



OPERATION MANUAL

ELECTRIC CHAIN HOIST MACHINE



DUKE

DUKE Electric Chain Hoist Introduction

The DUKE Electric Chain Hoist is designed for building sites, commercial and domestic, as well as various construction workplaces, such as warehousing, buildings, storage areas, factories in general, as well as domestic applications.

1. Preface	Page 3
2. Safety Instruction	Page 4
2-1. Safety regulations	Page 4
2-1-1. General safety rules	Page 4
2-1-2. Electrical safety rules	Page 5
2-1-3. Safety rules of hoist	Page 6
2-2. Location of warning sign, CE mark , nameplate	Page 7
2-3. All safety related elements	Page 8
2-4. Checklist of electrical and safety function	Page 9
3. Electric Chain Hoist Description	Page 10
3-1. General characteristics	Page 10
3-1-1. Usages	Page 10
3-1-2. Features	Page 10
3-2. Specifications	Page 11
3-3. Overall Dimensions	Page 12
3-4. Working space required and operating position	Page 13
3-5. Main units and name	Page 14
4. Pre-use Preparation	Page 15
4-1. Notice and inspection before operation	Page 15
4-1-1. Mechanical Check	Page 15
4-1-2. Electrical Check	Page 15
4-2. Expected use and limits of use	Page 16
5. Transport, Install and Dismantle	Page 17
5-1. Transport	Page 17
5-2. Install	Page 18
5-2-1. Power & Control System	Page 18
5-2-2. Preliminary Checks	Page 18
5-2-3. Continuous rating	Page 22
6. Control device: Control panel	Page 23
6-1. Control device: Control panel	Page 23
6-2. Operating procedure	Page 23
6-3. Handling Precautions	Page 24
7. Maintenance and Adjustment	Page 25
7-1. Inspections & Maintenance	Page 25
7-2. Troubleshooting	Page 32
8. Drawings and Part list	Page 35
8-1. Assembly drawings and part list	Page 35
8-2. Electrical system drawings and part list	Page 41

1. Preface

CONTENTS

- Please read this Instruction Manual carefully before you start using the electric hoist. You will find many useful hints which will help you to keep the hoist always in its first-class condition.
- You are kindly requested to read this manual thoroughly, to follow scrupulously the instructions given and for safety reasons, avoid controlling, adjusting or performing procedures other than those specified.
- This hoist has been designed and built in full compliance with EN ISO 12100, ISO 14121 and EN 60204 standards on machine and further modification, with high-quality materials and particularly studying the possibilities to reduce as much as possible the risks of accident.
- Foreword to the operating instructions
The operating instructions are designed to familiarize the user with the hoist and its designated use.
- The instruction manual contains important information on how to operate the hoist safely, properly and most efficiently. Observing these instructions helps to avoid danger, to reduce repair costs and downtimes and to increase the reliability and life of the hoist.
- The instruction manual is to be supplemented by the respective national rules and regulations for accident prevention and environmental protection.
The operating instructions must always be available wherever the hoist is in use.
These operating instructions must be applied by any person in charge of carrying out work with and on the hoist, such as
 - operation including setting up, troubleshooting in the course of work, care of consumables
 - maintenance (servicing, inspection, repair) and/or
 - transport

This electric hoist is designed and built in full compliance with the safety standard, please read carefully before installing the machine. You will find many hints to keep the machine in its best condition, also to avoid the risk of accident.
- In addition to the operating instructions and to the mandatory rules and regulations for accident
- Prevention and environment protection in the country and place of use of the hoist, the generally recognized technical rules for safe and proper working must also be observed.

2. Safety Instruction

2-1 Safety regulations

2-1-1 General safety rules

1. This electric hoist is designed for lifting products only. Do not apply the electric hoist for lifting person.
2. The electric hoist should be mounted on a flat solid place.
3. Installing the electric hoist at a proper levelling condition to ensure the chain arranged neatly. This may avoid chain friction against the hoist body.
4. Make sure your power source comply with the voltage indicated on the electric hoist before connecting the power wires to the power source.
5. Connect the power wires. Tighten the terminals securely.
6. Make sure the electric hoist has been properly grounded. The power circuit should be equipped with an electric shock breaker.
7. Before operating the electric hoist, read and follow the instructions for allowable lifting weight, speed and voltage etc. Indicated on the attached plate.
8. Do not exceed the rated lifting capacity of the electric hoist. Allowable lifting weight is indicated on the attached plate.
9. The electric hoist should be operated by a skilled operator. Before operating the electric hoist check again if all lock screws are tightened securely without loosening.
10. Before operating the electric hoist check to see if the chain runs to the correct direction and the brake works normally.
11. Do not allow any person approaches under the electric hoist, bracket or weight.
12. Select a proper location for mounting the electric hoist, to prevent the lifting weight bumping against any construction, steel frame or construction beam etc while lifting.
13. Always keep the chain in a good condition.
14. Lift weight vertically. Do not lift weight in a slant or horizontal direction. Do not have weight hooked on the chain for a long time.
15. Do not use the electric hoist to pull out any object fixed in the floor or any construction.
16. When the electric hoist is running, keep your hands or any object away from it to avoid danger.
17. Prevent control wire or power wire from hooking or contacting by the chain. This may avoid electric shock or any danger.

18. In case any malfunction or abnormal noise occurs during operation, stop the electric hoist immediately. Check and repair it immediately for safety.
19. Do not alter the electric circuit or use any other replacement parts not supplied from the original manufacturer.. This avoids affection on the hoist performance or any accident.
20. The operator is requested to fully obey the safety rules listed for safety protection.

2-1-2 Electrical safety rules



1. Before installing, please pay attention to the input rated voltage and current and make sure the hoist is grounded, in order to prevent accident.
2. There must be a main power switch (main breaker) at main input side of electric control system.
3. Remember to disconnect the main power before repair, maintenance and clean.
4. Unauthorized or untrained personnel cannot repair or maintain any electric equipment.
5. The keys of electric box and mode select should be conserved by authorized personnel. Don't give the key or authorized code to unauthorized personnel.
6. Comply with the maintenance instruction to repair and maintain the electric equipment.
7. Before operating the hoist, check all of the electric equipment and parts are broken or damaged or not. If there is something broken or damaged, replace a new one immediately and please note its original rated specification.
8. After connecting power, check the direction of motor rotation and the direction of hoist is correct or not.
9. Please check whether the function of emergency stop button is normal or not. The emergency stop button is used under emergency situation to cut off power of hoist. (Operator usually misunderstand that the hoist is broken down when they forgot to release the emergency stop button.)
10. Please check whether the function of each safety parts is normal or not, such as emergency stop button, emergency stop wire, interlocking switch, main power switch, safety valve, limit switch, and etc.
11. Please check whether the screws of each terminal base are tightened or not. If the screws loose, screw them tightly.
12. The wiring practices of electric control system must be complied with circuit diagram.

2-1-3 Safety rules of hoist

1. Don't misuse the hoist, to avoid danger.
2. Before start the hoist, make sure all the protecting covers are not breakdown and damage.
3. If the mechanism or any part breakdown, operator should stop the hoist immediately and then examine and repair it.
4. If it results abnormal sound during operation, operator should stop the hoist immediately and then examine and repair it.
5. If abnormal temperature phenomenon happens during operation, operator should stop the hoist immediately and then examine and repair it.
6. Don't modify the original design of mechanical structure, in order to keep the best efficiency and security.
7. Please store the spare parts and tools well, and avoid moist and damage.
8. Untrained or unauthorized operator is prohibited operating, installing or maintaining hoist.
9. Please maintain and repair the hoist according to service instruction.
10. Please replace broken part according to the specification in part list.

2-2. Location of warning sign, CE mark, nameplate



<p>Electric shock</p>

<p>CE symbol</p>

<p>Nameplate</p>

2-3. All safety related elements



ITEM	DESCRIPTION
1	Induction motor
2	Gear brake
3	Chain stop block
4	Chain guide spring
5	Emergency stop switch

2-4. Checklist of electrical and safety function

Item	Content inspection and safety requirement	Result	Comment
1	Is every terminal protected by isolation plate?	YES	
2	Does technician follow the procedure number to wire?	YES	
3	Are the diameter of grounding wire and each circuit accord with safety requirement of designed electrical circuit?	YES	
4	Is fuse accord with safety requirement of designed electrical circuit?	YES	
5	Are these screws on electric box fixed tightly?	YES	
6	Is the electric box equipped with a ventilator (e.g. fan)?	YES	
7	Does the design of electric box conform to IP requirement?	YES	
8	Is all the function of every control switch and component described specifically on this operation manual?	YES	
9	Are input voltage, frequency, and phase marked correctly?	YES	
10	Is the machine earthed?	YES	
11	Is there an independent earth copper plate equipped inside electric box?	YES	
12	Is every function of control device regular?	YES	
13	Is the emergency stop device functional?	YES	
14	Is the rotary direction of motor or transmission correct?	YES	
15	Is the cover functional (fixed or movable)?	YES	
16	Is the machine set stable?	YES	
17	Have all the acute angle and fur been ground?	YES	
18	Has the machine been pasted a CE mark?	YES	
19	Has the machine been pasted a nameplate?	YES	
20	Has the machine been pasted related warning marks?	YES	
21	Have the listed related safety parts in TCF 1.6 been installed indeed?	YES	
22	Have all the safety information and attentions been provided completely for user?	YES	
23	Does the written language of manual and machine conform to local country?	YES	
24	Has the operation manual been provided?	YES	
25	Has the EC Declaration of Conformity been signed?	YES	

3. Electric Chain Hoist Description

3-1 General characteristics

3-1-1 Usages

Fit for various workplace applications, such as general factories, warehouse, construction, plumbing, and agriculture industries. Designed for unique rigging applications encountered at small venues, lightweight, quiet, and portable. Operates on 415V, which means you can plug it in just about anywhere.

3-1-2 Features

Braking: Dual braking system combines mechanical plus regenerative braking, provides instant and safe braking.

Gearing: Precision machined gears heat treated for strength and durability, the ball or needle bearings at all rotating points run in oil bath lubrication for a quieter, smoother and cooler operation.

Loading sheave: Provide smooth lifting, reduce vibration and wear.

Housing: Lightweight, cast aluminum alloy

Chain: Designed and manufactured by FEC, Japan, grade 80 alloy steel with resistance and long life service.

Chain bag: The vinyl chain bag container is provided standard with hoist.

Switch: Simply layout of the control with 3M power cable as standard and emergency stop as option.

3-2 Specifications

Model	DU-905	DU-906	DU-102C
Dimensions			
Length (mm)	430	470	468
Width (mm)	290	290	293
Height (mm)	600	600	241
Capacity (kg)	1000	2000	2000
Standard Lift(m)			
Control Cable(m)	3	3	3
Lifting Speed(m/min)	6	3	18
Chain(mm)	7.1mm x 20.2mm		
Safety Factor	WLL x 1.25		
Insulation Class	F		
ED%	40%		
No. Of Starts per hr	240		
Power Cable (m)	1.5	1.5	1.5
Net Weight (kg)	47	55	39

3-3 Overall dimensions

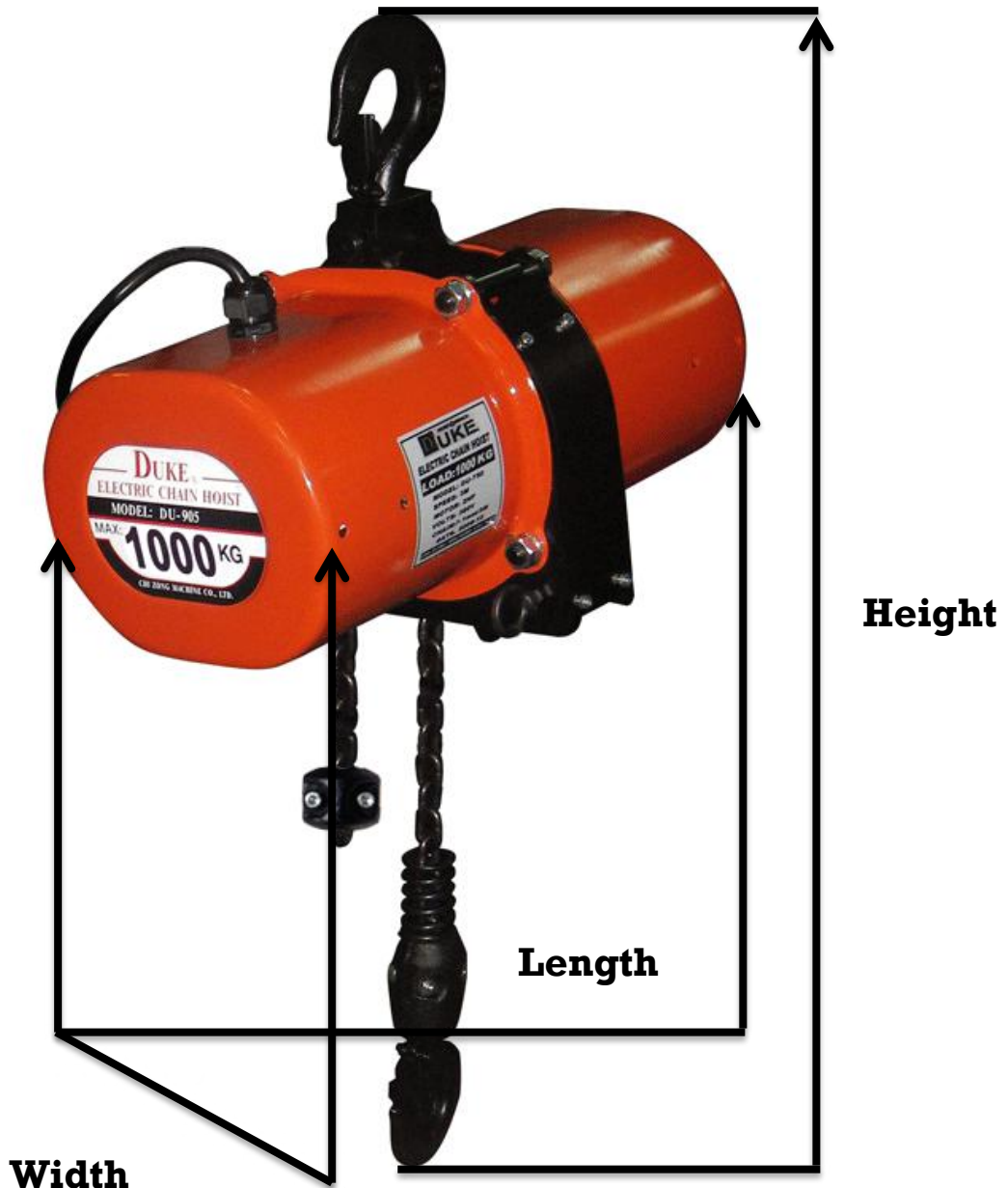

MODEL	Length	Width	Height
DU-905	430mm	290mm	600mm
DU-906	430mm	290mm	600mm
DU-102C	470mm	295mm	241mm

3-4 Working space required and operating position



FRONT OPERATOR

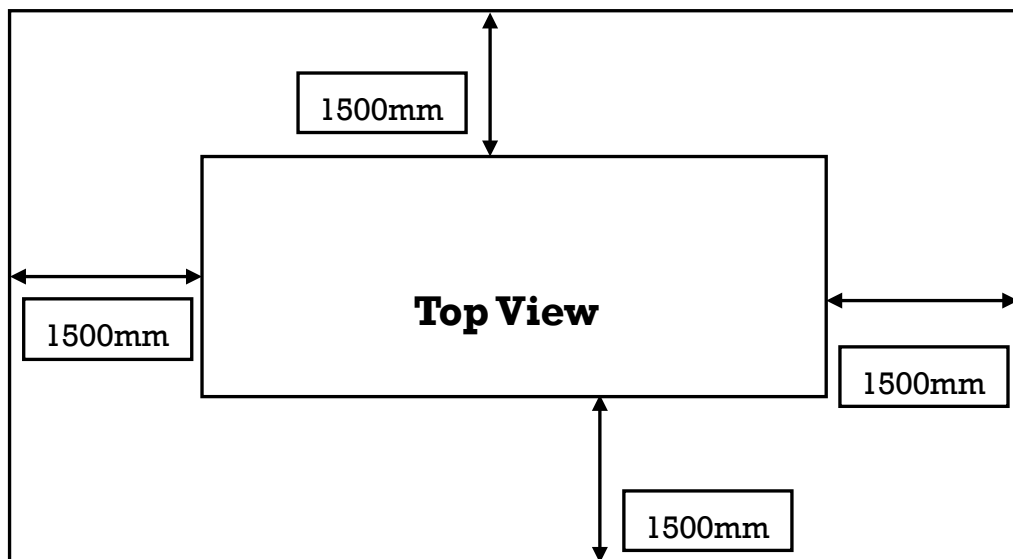

FRONT OPERATOR



3-5 Main units and name



Item	Part's name
1	Motor
2	Chain stop block
3	Lifting hook
4	7.1mm Chain
5	Gear
6	Suspension hook

4. Pre-use Preparation

4-1 Notice and inspection before operation

4-1-1 Mechanical Check

1. Are all transport protection facilities removed?
2. Is there any mechanical damage?
3. Are all the safety device, safety covers refitted from the set-up installation?
4. Are all hoist unit correctly aligned and locked in position?
5. Are all mobile and rotating parts exempt of foreign bodies? Is there mobility unimpaired (tools wire, yarns, waste, etc.)

4-1-2 Electrical Check

1. Are all ground conductors connected?
2. Are all cables connected?
3. Is there any mechanical damage of electrical control operating and indicator units
4. Are all plug-in connection to the wing fitted correctly?
5. Are all the cable near mobile parts fixed correctly?
6. Are the cable fitting tightened?
7. Were wire rests and metal objects removed and cleaned away from switch box, junction box, control cabinets, and operating panel?
8. Are frequency inverters motor set for the correct V/Hz ratio if applied?
9. Are the drive rotating direction correct?

4-2 Expected use and limits of use

Specification of essential parts:

Please refer to the list of specification in operation manual.

This hoist is expected to be used under industrial environment:

The well lighting, well ventilation, clean environment, dry, and maintains a normal temperature (-10°C to +50°C).

The hoist needs the following supplies:

Electric power: 3 phase/ 415V (or base on previous designation).

Working Duty (ED%):

40%.

No more than 24 minutes use within 60 minutes frame.

The required technique and experience during safety operation and use.

They should be a proficient operator or trained staff.

5. Transport, Install and Dismantle

5-1 Transport

Always carry the hoist with two hands to prevent a strike.

Below table shows net weight and gross weight for each model of hoist.



MODEL	NET WEIGHT	GROSS WEIGHT
DU-905	47.0 KGS	50.0 KGS
DU-906	55.0 KGS	58.0 KGS
DU-102C	39.0KGS	40.0KGS

5-2 Install

5-2-1 POWER & CONTROL SYSTEM

- **REQUIREMENTS**

The DUKE hoist comes in a direct control. They must be connected to a power and control system that is properly designed to operate the chain hoist and to handle the power consumption of the motor. DUKE hoists are standard wired for 3 phase/ 415V operations. For other voltages the chain hoist motor can be re-wired internally upon request.



5-2-2 PRELIMINARY CHECKS

Before installing / starting to use the chain hoist, check the following:

- **General:**

1. After unpacking the unit, carefully inspect for any damage that may have occurred during transit. Check for loose, missing or damaged parts. Shipping damage claims must be filed with the carrier. Be sure that the voltage labeled on the unit matches your power supply.
2. Make sure all supporting structures and attaching devices have the strength to safely absorb the weight of the intended loads. If in doubt, consult a qualified structural engineer. Power cables to chain hoists must include a ground conductor. If in doubt, consult a qualified structural engineer.
3. Chain hoists should not experience voltage drops of more than 10% of the supply voltage. It is critical to use adequate sized power cable.
4. The user's control board must be grounded in accordance with the electrical codes that are applicable in the local area. Power cable to chain hoists must include a ground conductor. The power cable includes a yellow/green ground conductor.
5. The installation area must provide safe operating conditions for the operator, including sufficient room for the operator and other personnel to stand clear of the load at all times.

• **RIGGING THE HOIST:**



CAUTION

Part of this procedure can involve working from an elevated platform, scissors lift or cherry picker. Before doing so make sure you are competent to work with those and take all safety precautions needed.

1. Before each use, visually inspect the hoist and all load bearing parts of the hoist, like hook and chain.
2. Make sure the intended structural support component is able to safely absorb the chain hoist lifting capacity.
3. Attach the chain bag to the chain bag ring.
4. Put the chain into the chain bag and make sure there are no twists or knots in the chain in the chain bag.
5. Attach the chain hook to the main structural support member, either direct to an existing eyebolt or lug-plate, or using a bracket or beam clamp. It is also possible to use a sling or bridle. Avoid slinging on sharp edges.



WARNING

A fully loaded motor can put considerably higher forces to the support structure when dynamic forces are induced. A similar thing happens when a lowering movement of other hoists on the same load (e.g. truss-structure) causes the centre of gravity to slide towards the resting hoist, which will get overloaded. Overload protection in the chain hoist causes the structure to be overloaded as well.

6. Connect the power (and control) cable and make sure these will have proper stress relieves and sufficient slack in every direction of planned tilting of the load. Use Velcro or cable-strings to tie the cable to the hoist body or lifting hook.
7. Lower the chain hook by letting the chain run out to the required height.
8. Put the load under the chain hook.
9. Attach the load to the chain hook, either to a lug plate, eyebolt or using one or more slings.

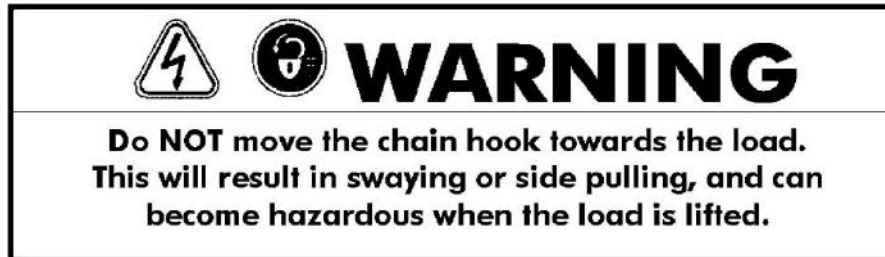

10. Run the chain up until the load chain just taut.
11. Check all lifting and slinging connections, and lift the load until it is freely floating of the ground.
12. Visually check the whole lifting structure from chain hoist and cable through the load chain down to the load.



13. Remove all people from the area before you start lifting the load. Do not allow any people to stand under the moving load.
14. Make sure you have a full visual view on the complete travel path of the load.
15. Lift the load to the required height.



16. Add a secondary in between support structure and the load when persons have to get under the load.
17. Make sure this secondary is as tight as possible, preferably using clutch-chains.



• **DE-RIGGING THE HOIST:**

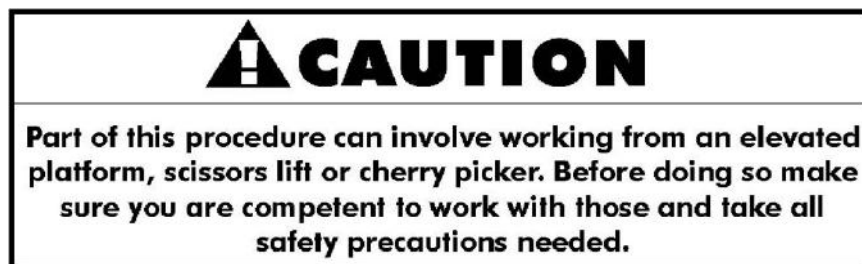

1. Remove the secondary (when present).
2. Check the direction of travel. If the pre-selection switch on the controller is in the down-direction the chain hoist should run in down-direction.
3. Check if both the lifting directions work properly (lifting and lowering).
Remove all people from the area before you start lowering the load. Do not allow any people to stand under the moving load.



5. Make sure you have a full visual view on the complete travel path of the load.
6. Bring the load down until within reach for further dismantling.
7. Remove all parts of the load and slings attached the chain hook.
8. Disconnect the power and control cables.
9. Remove the chain hoist from the suspension structure and bring it down.
10. Put the chain hoist and the chain bag in their compartments of the flight case (when applicable).
11. Remove any bracket, beam clamp or sling from the main structure elements.

5-2-3 Continuous rating

Never use the hoist beyond the 24 minutes permitted per hour.

The life of the hoist depends on the conditions of the load and working frequency. During long operating periods make sure to use the hoist within its continuous rating.

Continuous Rating means the amount of allowable usage within one hour which is 40% or 24 minutes per hour or 240 starts per hour.

The maximum number of starts means the number of times the motor starts within the hour.

6. Operation

6-1 Control device: Control panel

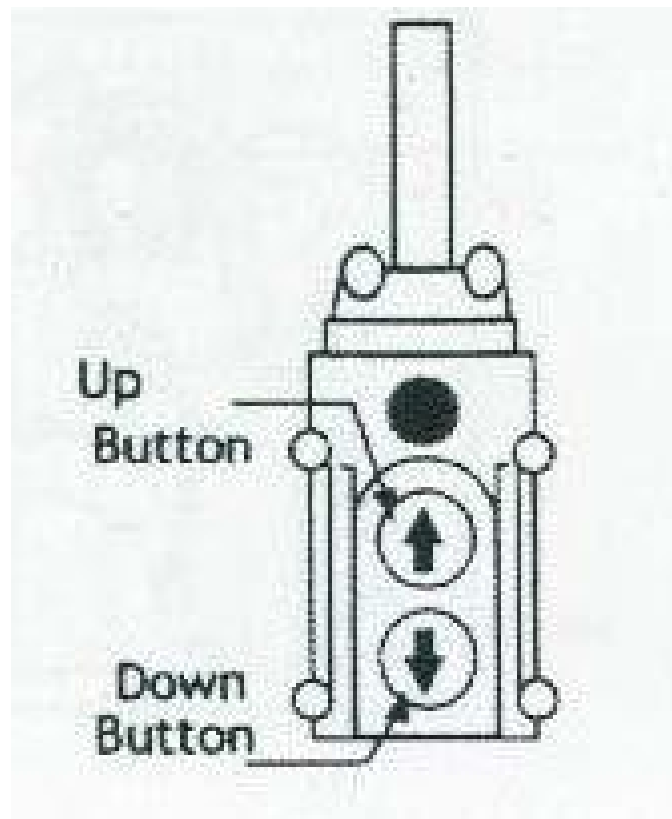

6-2 Operating procedure

The person who is untrained or unfamiliar with the operation procedure is prohibited from operating machine.

• Preparation before Working

- Check all safety and environmental conditions
- Check the load chain and discard should there be any signs of excessive wear, too many broken chain links, corrosion, or other defects.
- Connect the main power source and ensure grounding.
- Do not lift loads exceeding the rated load.
- Always use power source at the rated voltage.

• Up and Down Control Switch

- **To Lift a Load. Press ▲ Button**
- **To Lower a Load. Press ▼ Button**

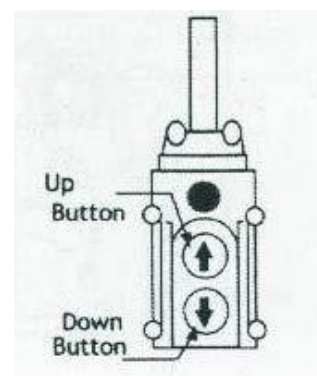

6-3 Handling Precautions

1. Check to ensure that the load point is in the line with the hoist head.
2. When applying a load, it must be directly in line with hoist. Avoid off-center loading of any kind.
3. Take up a slack load chain carefully and start load easily to avoid shock and jerking of hoist load chain. if there is any evidence of overloading, immediately lower the load and remove the excess load.
4. Do not allow the load to swing or twist while lifting.
5. Do not allow the load and/or attachments to bear against the hook latch and/or hook tip. Apply load to hook bowl or saddle only.
6. The DUKE can be mounted upright as “motor up” in the traditional industry situation or “motor down”, which has become standard in the entertainment touring industry. Always ensure that it is clear whether the load chain shall move or whether the hoist housing shall move. This does have effect on the way power and control cables should be run.
7. When installing a three phase chain hoist, check and make sure the chain hoist travels in the direction intended when operating the controls. To correct improper motor travel, reverse any two wires (except the yellow/ green ground wire) at the power source. Do not change the connection in the chain hoist. Once the direction of travel is verified to be correct, permanent connections can be made at the power source.

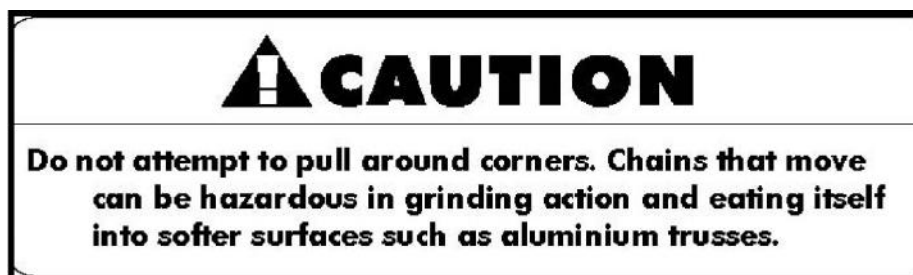

7. Maintenance and Adjustment

7-1 Inspections & Maintenance

To maintain continuous and satisfactory operation, a regular inspection procedure must be initiated to replace worn or damaged parts before they become unsafe. Inspection intervals must be determined by the individual application and are based on the type of service to which the hoist will be subjected to the degree of exposure to wear, deterioration or malfunction of the critical components.

The type of service to which the hoist is subjected can be classified as Normal, Heavy, or Severe.

Normal Service: Involves operation with randomly distributed loads within the rated load limit, or uniform loads less than 65% of rated load for not more than 25% of the time.

Heavy Service: Involves operating the hoist within the rated load limit which exceeds normal service.

Severe Service: Normal or heavy service with abnormal operating conditions.

Two classes of inspection- frequent and periodic – must be performed.

Frequent Inspections: These inspections are visual examinations by the operator or other designated personnel. Records of such inspections are not required. The frequent inspections are to be performed monthly for normal service, weekly to monthly for heavy service, and daily to weekly for severe service, and they should

Include those items listed in below.

Periodic Inspections: These inspections are visual inspections of external conditions by an appointed person. Records of periodic inspections are to be kept for continuing evaluation of the condition of the hoist.

Periodic inspections are to be performed yearly for normal service, semi-annually for heavy service and quarterly for severe service, and they are to include those items listed in below.

CAUTIONS: Any deficiencies are to be corrected before the hoist is returned to service. Also, the external conditions may show the need of disassembly to permit a more detailed inspection, which, in turn, may require use of nondestructive type testing.

• PREVENTIVE MAINTENANCE

In addition to the above inspection procedure, a preventive maintenance program should be established to prolong the useful life of the hoist and maintain its reliability and continued safe use. The program should include the periodic and frequent inspections with particular attention being paid to the lubrication of the various components using the recommended lubricants.

Minimum Frequent Inspections

TYPE OF SERVICE			ITEM	
Normal	Heavy	Severe		
Monthly	Weekly to Monthly	Daily to Weekly	a)	Brake for evidence of slippage.
			b)	Control functions for proper operation.
			c)	Hooks for damage, cracks, twists, excessive throat opening, latch engagement and latch operation.
			d)	Load chain for adequate lubrication, as well as signs of wear or damaged links.
			e)	Load chain for proper reeving and twists.

Minimum Periodic Inspections

TYPE OF SERVICE			ITEM	
Normal	Heavy	Severe		
			a)	All items in minimum frequent inspections
			b)	External evidence of loose screws, bolts or nuts.
			c)	External evidence of worn, corroded, cracked or distorted hook block, suspension screws, gears, bearings, chain stop and chain guide.
			d)	External evidence of damage to hook retaining nut and pin. Also check the upper suspension adapter making sure it is fully seated in the hoist frame and that both screws are tight.
			e)	External evidence of excessive wear of brake parts.
			f)	Checking the operation of the control station making sure the buttons operate freely and do not stick in either position.
			g)	Inspect the electrical cords and cables and control station enclosure for damaged insulation.
			h)	Inspect the suspension hook for excess free play or rotation. Replace worn parts as evidence by excess free play or rotation.

• HOOK INSPECTION

Hooks damaged from chemicals, deformations or cracks, or that have more than a 10 degree twist from the hook's unbent plane, excessive opening or seat wear must be replaced. Also, hooks that are opened and allow the latch to not engage the tip must be replaced. Any hook that is twisted or has excessive throat opening indicates abuse or overloading of the unit. Inspect other load sustaining parts, hook block screws, load pins and hook block bodies for damage.

Check to make sure that the latch is not damaged or bent and that it operates properly with sufficient spring pressure to keep the latch tightly against the tip of the hook and allow the latch to spring back to the tip when released. If the latch does not operate properly, it should be replaced.

To Measure opening, depress latch against hook body as show.

Replace the hooks when opening is greater than 38mm.

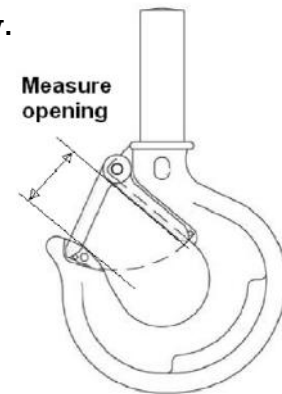

• CHAIN

1. Clean chain with a non-caustic/non-acid type solvent and make a link by link inspection for nicks, gouges, twisted links, weld splatter, corrosion pits, striations, cracks in weld areas, wear and stretching. Chain with any one of these defects must be replaced.
2. Slack the portion of the chain that normally passes over the liftwheel. Examine the interlink area for the point of maximum wear. Measure and record the stock diameter at this point of the link. Then measure stock diameter in the same area on a link that does not pass over the liftwheel and compare these two measurements.

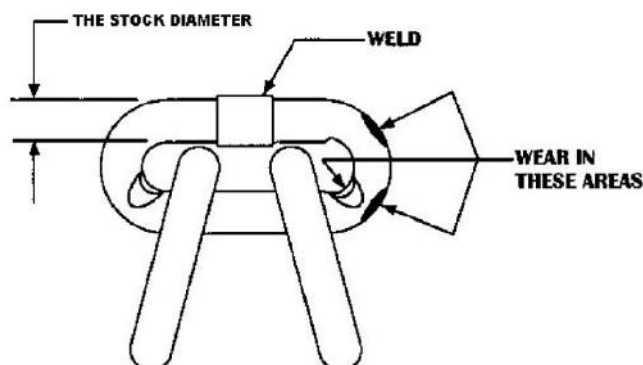

3. Also check chain for stretch using a larger caliper as show below to measure the outside length of a convenient number of links about 11(pitches). Measure the same number of links in a used section of chain and calculate the percentage increase in length of the worn chain.

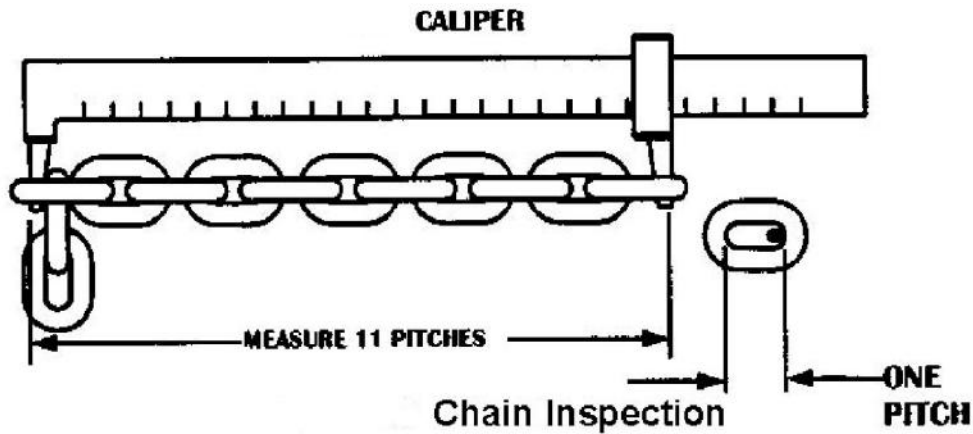

4. Chain is to be kept clean and lubricated. Visually check chain every time chain hoist is used. As oil needs to sit at the bearing surface of each chain link, it is advised to submerge the chain in oil for 30 min. Take it out and let the chain hang dripping for 24 hours before putting in the hoist.



Note: In the entertainment industry chain wear in general is only very limited, and often even impossible to measure after 10 years of normal use. On the other hand it is a well known fact that the load chains in the entertainment do tend to be misused or even abused and sometimes badly neglected in corrosion prevention. Severely damaged, deformed, dented, partly eaten or even broken chain links have been regularly reported by users in the entertainment sector, and constant attention must be given that such chains are immediately taken out of service. All this is typically the responsibility of the customer or user of the chain hoist.

• IDENTIFICATION OF CHAIN:

FEC load chain can be recognized and determined original by the following marks on the chain

Chain specifications:

- diameter-7.1mm
- pitch-20.2mm
- grade-Grade80
- type of marking-see sample picture below. Every 15 links.
- max. working load-1000kgs
- minimum breaking strength-6300kgs
- weight per meter- 1.12kg/m

For replacement load chains use FEC chain only.

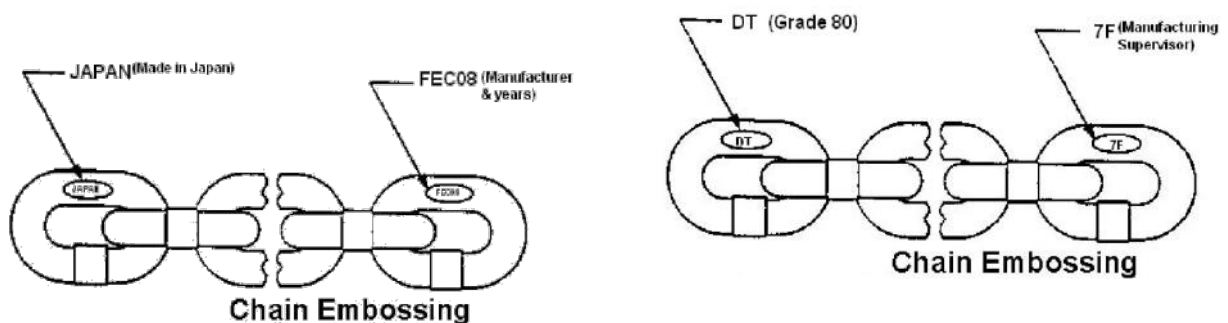

• CHAIN REPLACEMENT WITH CHAIN IN LIFTING MOTOR

1. With the unit placing on workbench or motor up position, run the hook to its up limit.
2. Remove the load block assembly from the old chain.
3. Make a “C” link, attach the new chain to the load end of the old chain.
4. Carefully jog the “UP” button and run the joined pieces of chain into the lifting motor until about 40cm of new chain comes out the other side.
5. Remove the “C” link and the old chain. Remove the chain stop from the old chain by a hex head screwdriver.
6. Attach the chain stop to the slack end of the new chain by capturing the 12th link with the two stop halves. Be sure there are no twists in the chain.
7. Attach the load block on new chain by a hex head screwdriver.



Make a “C” link

• **CHAIN REPLACEMENT WITH NO CHAIN IN CHAIN HOIST**

1. With the unit placing on workbench, run the hook to its up limit.
2. Remove the load block assembly from the old chain.
3. Remove the chain stop from the old chain.
4. Carefully jog the “UP” button and detach the old chain out of the lifting motor.
5. Insert the new chain into the load sheave.
6. Feed the new chain into the chain hoist by jogging the “DOWN” button.
7. Allow about 40cm of chain below the chain hoist on the slack end.
8. Attached the chain stop and load block assembly. Be sure there are no twists in the chain.

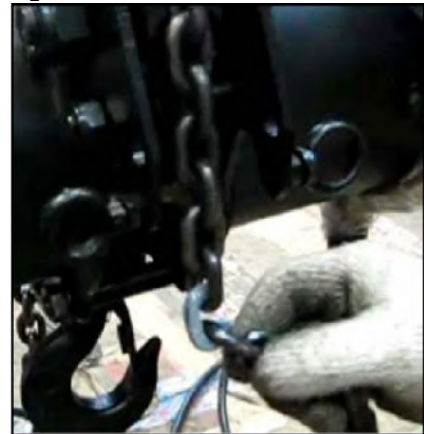

 CAUTION
TO AVOID INJURY: Use only Duke supplied replacement load chain and parts. Chain and parts may look alike, but Duke chain and parts are made of specific material or processed to achieve specific properties.

• **CHAIN END STOP**

The end stop on the dead-end chain should be mounted on the 11th link. (No less than 11 links should be in between the dead-end and the chain stop).

• **CUTTING CHAINS**

FEC load chain is hardened and therefore difficult to cut. The following methods are recommended when cutting a length of new chain from stock or cutting worn chain.

- a) Use a grinder and nick the link on both sides, then secure the link in a vise and break of with a hammer.



Cutting chain by Nicking

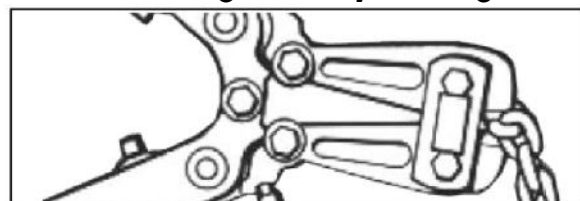

- b) Use a bolt cutter with special cutter jaws for cutting hardened chain.

Cutting chain with a Bolt Cutter

• **LOAD CHAIN CLEANING**

Clean the load chain with acid-free solvent and coat with new ISO VG-320 or equivalent gear oil. Wipe excess Oil to prevent dripping. Never apply grease to the chain.

Hook a load of 1.25 times the nominal load into the hoist.



• **SIGNS OF INADEQUATE ELECTRICAL POWER:**

The hoist must be supplied with adequate electrical power in order to operate properly. The signs of low voltage are:

- Noisy hoist operation due to brake and /or chattering.
- Dimming of lights or slowing of motors connected to the same circuit.
- Heating of the hoist motor and other internal components as well as heating of the wires and connectors in the circuit feeding the hoists.
- Failure of the hoist to lift the load due to motor stalling.

7-2 Troubleshooting

If the hoist fails to start after several attempts or the hoist's operation appears to be defective check the following:

TROUBLE SHOOTING FOR CHAIN HOIST		
Trouble	Probable Cause	Check and Remedy
1. Lifting motor does not respond to pushbutton	A) Power failure in supply line	A) Check circuit, breakers, switch and connection in power supply line
	B) Wrong voltage or frequency	B) Check voltage and frequency of power supply against the rating on the nameplate of the motor.
	C) Improper connections in chain hoist or push button	C) Check all connections at line connectors and on terminal block.
	D) Brake does not release	D) Check brake coil connection for open or short circuit. Check wiring for relay rectifier.
2. Hook does not stop promptly	A) Chain hoist overloaded	A) Reduce load within rated capacity of chain hoist.
	B) Brake not holding	B) Check brake and it may be necessary to replace discs.
3. Hook moves in wrong direction	A) Three phase reverse	A) Reverse any two wires (except the ground wire) at the power source.
	B) Improper connection	B) Check all connections against wiring diagram.
4. Chain hoist hesitates to lift when energized	A) Chain hoist overloaded	A) Reduce load within rated capacity of chain hoist.
	C) Low voltage	C) Determine cause of low voltage and bring up to within plus or minus 10% of the voltage specified on the motor. Measure voltage at the lifting motor in terminal block power input.
5. Hook raises but will not lower	A) "Down" circuit open	A) Check circuit for loose connections.
	B) Broken conductor in pushbutton cable	B) Check each conductor in the cable. If one is broken, reduce entire cable.

6. Hook lowers but will not raise	A) Lifting motor overload	A) Reduce load to within rated capacity of chain hoist.
	B) Low voltage	B) Determine cause of low voltage and bring up to within plus or minus 10% of the voltage specified on the motor. Measure voltage at the lifting motor in terminal block power input.
	C) "UP" circuit open	C) Check circuit for loose connections
	D) Broken conductor in pushbutton cable	D) Check each conductor in the cable. If one is broken, replace entire cable.
	E) Worn overload limiting clutch	E) Adjust or replace overload clutch assembly.
	F) Loose screw clamps	F) Ensure that screw clamps are tightened on the terminal blocks.
7. Motor overheats	A) Excessive load	A) Reduce load to within rated capacity of chain hoist
	B) Low voltage	B) Determine cause of low voltage and bring up to within plus or minus 10% of the voltage specified on the motor. Measure voltage at the lifting motor in terminal block power input.
	C) Frequent starting or reversing	C) Excessive inching, jogging or reversing should be avoided since this type of operation will drastically shorten the life of motor and brake.
	D) Brake dragging	D) Replace brake assembly
8. Lack of proper lifting speed	A) Chain hoist overload	A) Reduce load to within rated capacity of chain hoist
	B) Brake dragging	B) Replace brake assembly
	C) Low voltage	C) Determine cause of low voltage and bring up to within plus or minus 10% of the voltage specified on the motor. Measure voltage at the lifting motor in terminal block power input.

9. Motor brake noise or chatter (while starting chain hoist)	A) Brake needs replacement	A) Replace brake assembly
	B) Low voltage	B) Determine cause of low voltage and bring up to within plus or minus 10% of the voltage specified on the motor. Measure voltage at the lifting motor in terminal block power input.
10. Motor brake "buzz" (anytime chain hoist is running)	A) Brake needs replacement B) Broken brake coil	A) Replace brake assembly
		B) Replace the brake coil and check the relay rectifier.

NB: All mechanical or electrical work must be carried out by a qualified tradesperson

8. Drawings and Part list

8-1 Assembly drawings and part list

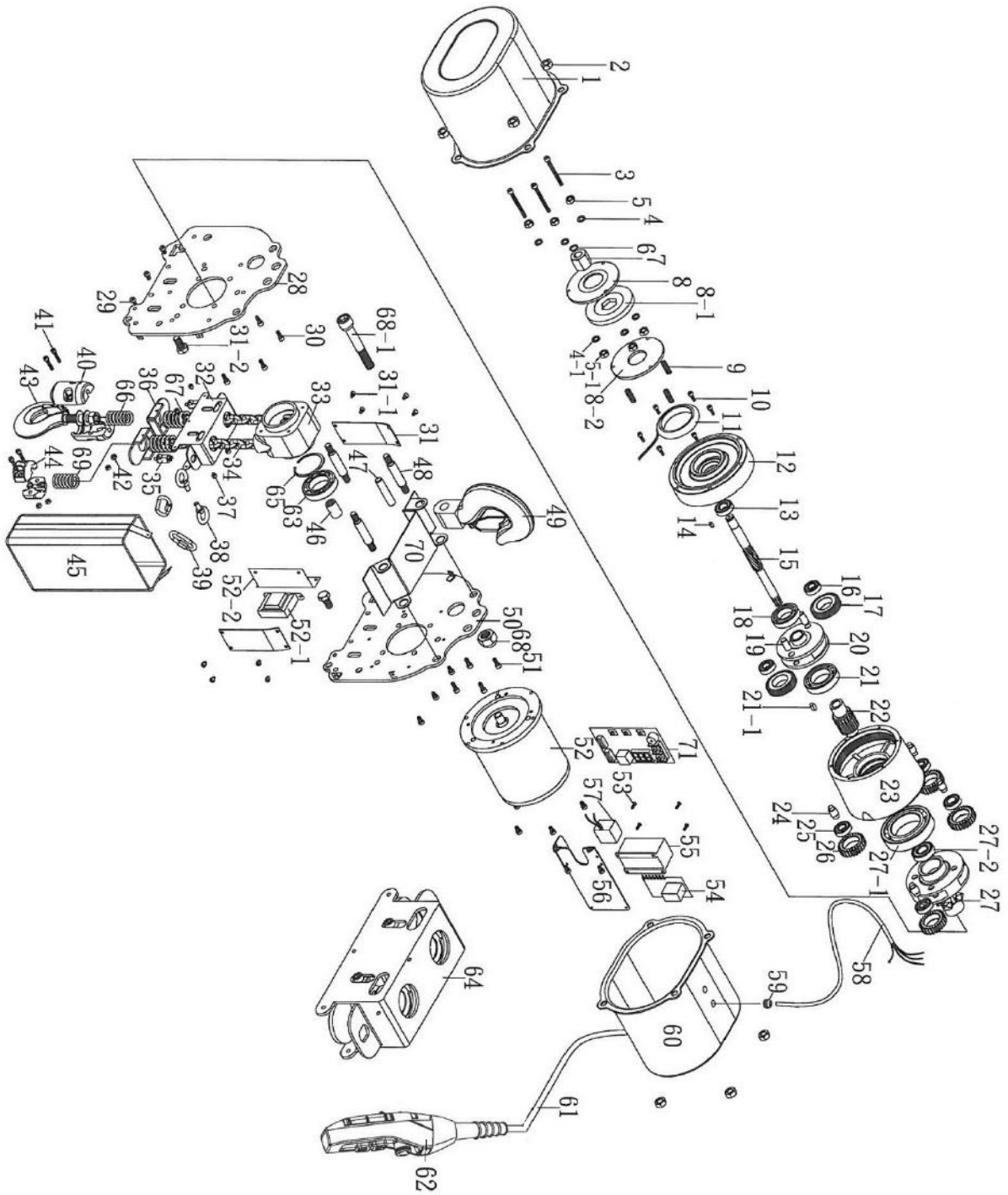

DU-905 PARTS DESCRIPTION

1	Gear end housing	31-2	Screw	67	Limit Spring
2	Nut	32	Limit Cover	68	Nut
3	Bolt	33	Chain Guide	68-1	Bolt
4	Washer	34	Chain (7.1mm x 20mm)	69	Limit Spring
4-1	Washer	35	Limit disconnecter	70	Top Cover
5	Nut	36	Limit switch base	71	Electric Overload Protector
5-1	Nut	37	Screw		
6	Fixing spring	38	Ring		
7	Nut	39	Loose end link		
8	Brake intermediate plate 1	40	Lifting hook block		
8-1	Brake Disc	41	Screw		
8-2	Brake intermediate plate 2	42	Nut		
9	Spring	43	Lifting hook		
10	Screw	44	Chain stop block		
11	Brake coil	45	Chain bag		
12	Brake base plate	46	Fix Rod		
13	Bearing	47	Fix Rod		
14	Drive shaft key	48	Fix Rod		
15	Drive shaft	49	Suspension hook		
16	Bearing	49-1	Hook base block		
17	Gear	50	Motor frame		
18	Bearing	51	Motor frame screws		
19	Rod of gear shaft	52	Motor		
20	Fixing base of gear shaft	52-1	Transformer		
21	Bearing	52-2	Transformer Fixer		
21-1	Key	53	Screw		
22	Gear Shaft	54	Circuit board		
23	Gear hub	55	Magnetic Contactor		
24	Rod of gear shaft	56	Circuit board holder		
25	Bearing	57	Regulator		
26	Gear	58	Power Cord		
27	Chain Guide Shaft	59	Cable gland		
27-1	Bearing	60	Motor end housing		
27-2	Bearing	61	Control Cord (1.25mm x 3C)		
28	Gear frame	62	Control switch w/o cord		
29	Screw	63	Bearing		
30	Screw	64	Limit switch ass'y		
31	Side Cover	65	Snap ring		
31-1	Screw	66	Limit Spring		

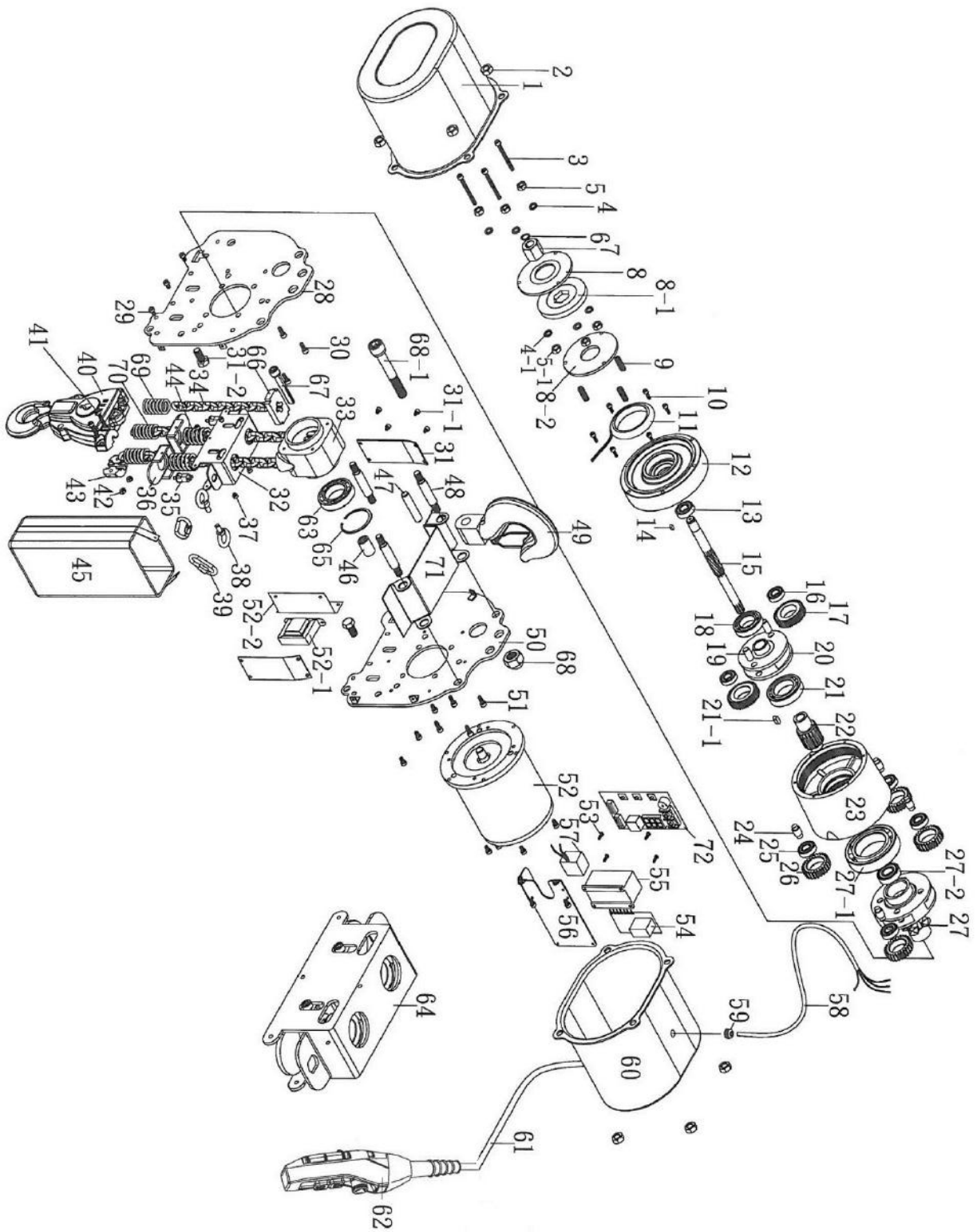

DU-906 PARTS DESCRIPTION

1	Gear end housing	31-2	Screw	68	Nut
2	Nut	32	Limit Cover	68-1	Bolt
3	Bolt	33	Chain Guide	69	Limit Spring
4	Washer	34	Chain (7.1mm x 20mm)	70	Limit Spring
4-1	Washer	35	Limit disconnecter	71	Top Cover
5	Nut	36	Limit switch base	72	Electric Overload Protector
5-1	Nut	37	Screw		
6	Fixing spring	38	Ring		
7	Nut	39	Loose end link		
8	Brake intermediate plate 1	40	Lifting hook block		
8-1	Brake Disc	41	Screw		
8-2	Brake intermediate plate 2	42	Nut		
9	Spring	43	Chain stop block		
10	Screw	44	Spring		
11	Brake coil	45	Chain bag		
12	Brake base plate	46	Fix Rod		
13	Bearing	47	Fix Rod		
14	Drive shaft key	48	Fix Rod		
15	Drive shaft	49	Suspension hook		
16	Bearing	50	Motor frame		
17	Gear	51	Motor frame screws		
18	Bearing	52	Motor		
19	Rod of gear shaft	52-1	Transformer		
20	Fixing base of gear shaft	52-2	TransformerFixer		
21	Bearing	53	Screw		
21-1	Key	54	Circuit board		
22	Gear Shaft	55	Magnetic Contactor		
23	Gear hub	56	Circuit board holder		
24	Rod of gear shaft	57	Regulator		
25	Bearing	58	Power Cord		
26	Gear	59	Cable gland		
27	Chain Guide Shaft	60	Motor end housing		
27-1	Bearing	61	Control Cord (1.25mm x 3C)		
27-2	Bearing	62	Control switch w/o cord		
28	Gear frame	63	Bearing		
29	Screw	64	Limit switch ass'y		
30	Screw	65	Snap ring		
31	Side Cover	66	Cross Type Board		
31-1	Screw	67	Chain Bolt		

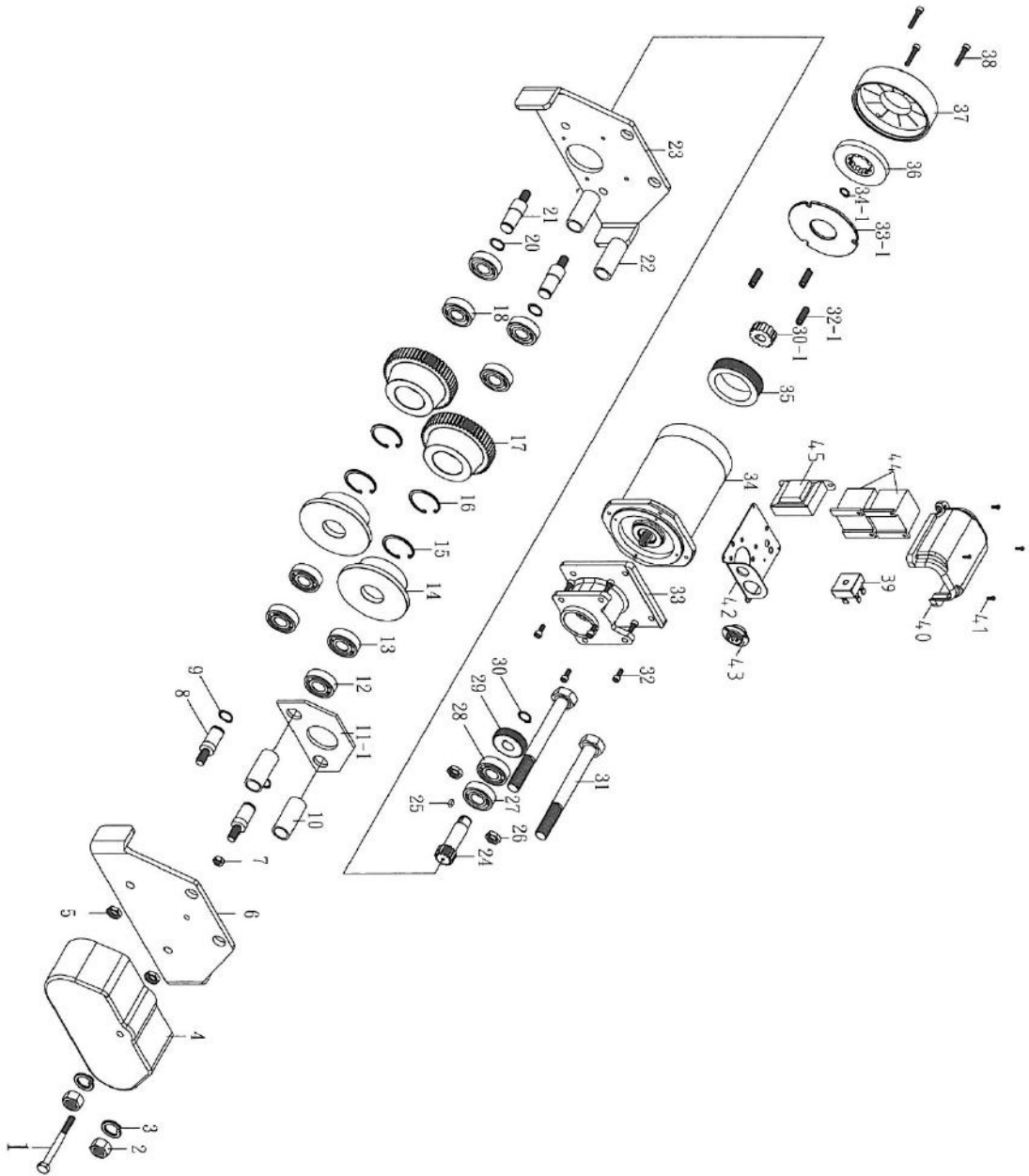

1	Screw	25	Shaft Key
2	Nut	26	Nut
3	Spring Washer	27	Bearing
4	Counterweight Block	28	Bearing
5	Nut	29	Gear
6	Body Plate (Block Side)	30	Snap Ring
7	Nut	30-1	Braking Gear
8	Shaft (w/o Gear)	31	Bolt
9	Snap Ring	32	Screw
10	Pipe	32-1	Compression Spring
11	Screwed Fix Plate	33	Gear Housing
11-1	Hooked Fix Plate	33-1	Braking Plate
12	Bearing	34	Motor
13	Bearing	34-1	Snap Ring
14	Pulley (w/o Gear)	35	Braking Coil
15	Snap Ring	36	Braking Disc
16	Snap Ring	37	Brake Cover
17	Pulley (w/ Gear)	38	Screw
18	Bearing	39	Rectifier
19	Screwed Fix Plate	40	Control Box Cover
20	Snap Ring	41	Screw
21	Shaft (w Gear)	42	Control Box Mount
22	Pipe	43	Quiack Connector
23	Body Plate (Motor Side)	44	Contactora
24	Gear Shaft	45	Adapter

8-2 Electrical system drawings and part list

MODEL:DU-905 / DU-906 - Electrical system drawings

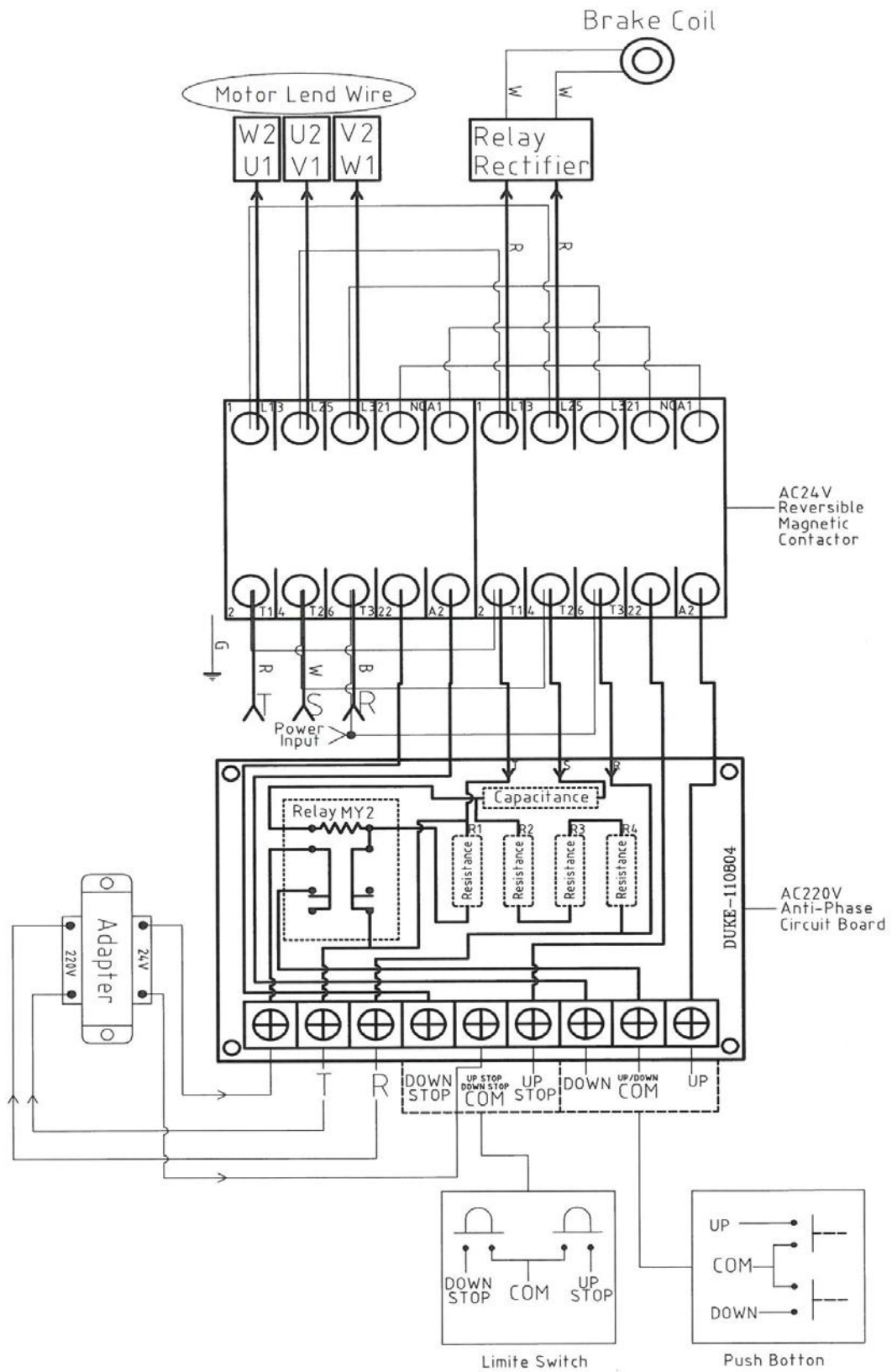

MODEL:DU-102C - Electrical system drawings

